

## INSTALLATION & MAINTENANCE INSTRUCTIONS RECTANGULAR COVER AND CUSTOM COVERS

**PLEASE NOTE:** If the cover is going to be anchored into a raised bond beam, spa, wall, waterfall, etc., proceed to the instructions on the top of the reverse side.

### INSTALLING A RECTANGULAR COVER

#### STEP 1

Inspect the area 18" back from the water's edge around the entire pool. Remove any irregular obstructions that may protrude through the cover. Pad rough coping, sharp edges, and inside corners with carpet, foam or similar material. Excessive wear due to non-padded areas is specifically excluded from the warranty.

#### STEP 2

Measure exact dimensions of swimming pool and cover. From the difference between these measurements, adjust the overlap so that it is equal at all corners of the pool. Though standard overlaps are 12", they may vary several inches either way.

#### STEP 3

Measure 18" from corner of cover in each direction and locate position point (A) of anchors for all four corners.

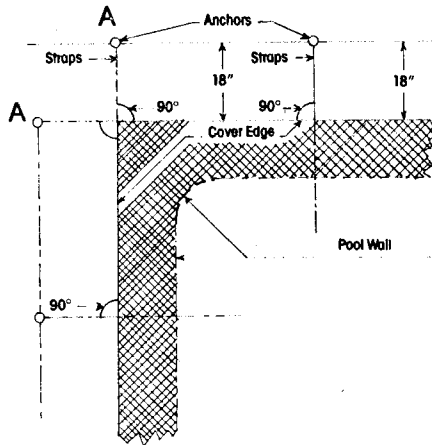

#### STEP 4

Install the 8 anchors at the 4 corners and step section if applicable. (see Anchor Installation on reverse side). Attach triangle shaped side of springs to corner straps (see spring attached to cover for proper spring attachment). Next, install the springs on anchors using the Installation Rod (see Cover Installation on reverse side). Adjust buckles so that springs will compress about 60-70% for a taut fit.

#### STEP 5

Once all corners are secured, install remaining anchors 18" from the cover's edge in line with each strap. Make certain the same overlap is maintained as in the corners and that the straps are at a 90° (right angles) to the cover's edge. Adhere to right angles, or bulges and/or gaps will occur.

**IMPORTANT:** SECUR&CLEAN<sup>®</sup> solid covers must be adjusted after installation to ensure that water does not collect on top of cover. After installation, flood cover with water. If standing water forms puddles that do not drain, simply loosen straps on either side of the drain and tighten straps in the areas with the standing water.

### INSTALLING A CUSTOM COVER

#### STEP 1

See Step 1 instructions for installing a "Rectangular Cover."

#### STEP 2

Measure exact dimensions of swimming pool and cover. From the difference between these measurements, adjust the overlap so that it is equal at all locations of the pool. Though standard overlaps are 15", they may vary several inches either way.

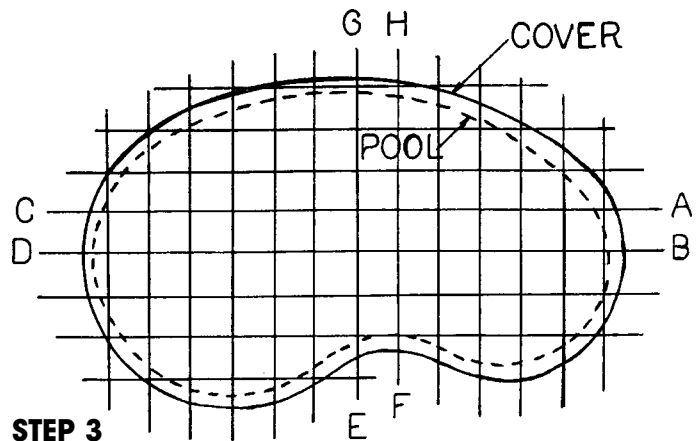

#### STEP 3

Locate anchor locations on Figure 1. Begin with strap location (A) and measure 18" from cover. Mark this location on the deck. Continue for straps (B), (C) & (D).

#### STEP 4

Install the anchors for (A), (B), (C), & (D) (see Anchor Installation on reverse side) and attach triangle shaped side of spring to cover straps (see the spring attached to cover for proper spring attachment). Next, install the springs on anchors using the Installation Rod (see Cover Installation on reverse side). Adjust the buckles so that springs will compress about 60-70% for a taut fit.

#### STEP 5

Continue with installing straps and anchors (E), (F), (G) & (H) as indicated on Figure 1.

#### STEP 6

After completing the initial installation of the first 8 anchors, install the remaining anchors working from the center of the cover to the ends. Remember to alternate sides and to attach and secure each spring to the cover as each anchor is installed.

# RAISED BOND BEAM, SPA WALL, WATERFALL, WALL & ROCK

Springs and anchors do not work well in these circumstances, as the obstructions are at the coping edge. Snaphooks sewn to the underside of the cover are fastened to the eyebolts which are secured into the wall or obstruction.

## STEP 1

Locate anchor positions using the enclosed plan.

## STEP 2

Use stainless steel  $\frac{5}{16}$ " diameter eyebolts with 1" eye. Drill  $\frac{5}{8}$ " hole and secure anchors into foundation. Insert eyebolt into casings and secure.

## STEP 3

Fasten snaphooks on cover to eyebolts.

## STEP 4

Continue with cover installation on front page.

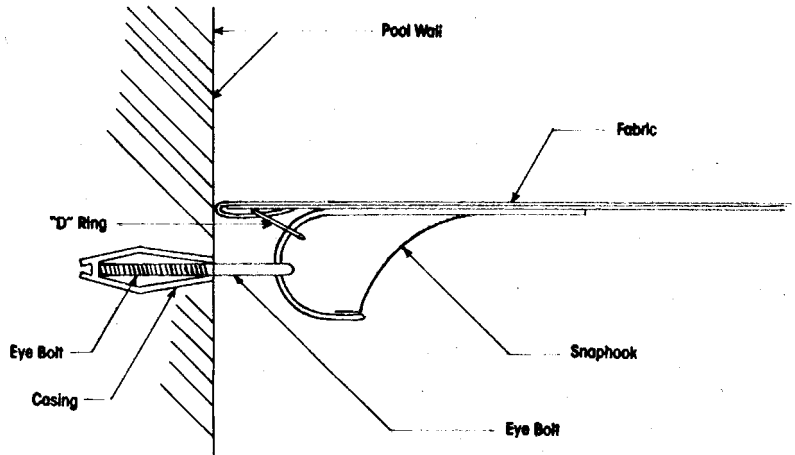

## WOOD ANCHOR INSTALLATION

### STEP 1

Install wood anchor by drilling a  $1\frac{1}{2}$ " diameter hole to depth of  $\frac{1}{8}$ " with a wing bit.

### STEP 2

Drill a  $\frac{3}{4}$ " diameter hole in the center of the wing bit hole to a final depth of 1".

### STEP 3

Insert anchor into hole so it is flush with the deck surface. Proceed with screwing the wood screws into the existing holes. Spray anchor and casing with silicone. Then insert the anchor screw using the hex key.

### WOOD DECK ANCHOR

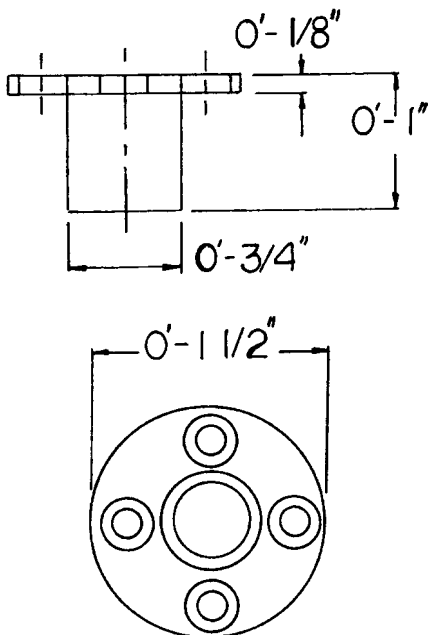

## ANCHOR INSTALLATION

### STEP 1

Install brass anchors by drilling  $\frac{3}{4}$ " diameter holes to a depth of 2". Bevel or ream the top of the hole for flush fit. Remove anchor screw from casing. Spray anchor, screw casing and aluminum tamping tool with silicone.

### STEP 2

Insert tamping tool and tap the retainer into place. The slotted screw may be reinserted using the hex key.

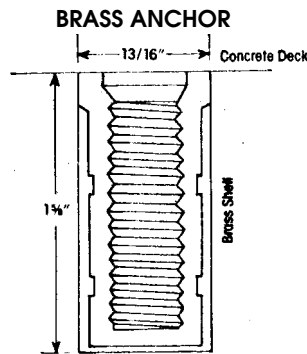

## COVER REMOVAL

Insert installation rod over anchor with notch away from pool (Diagram C). Next, press down and rotate 180°. Heel of rod will force spring free of anchor. Tilt rod to release spring (Diagram D).

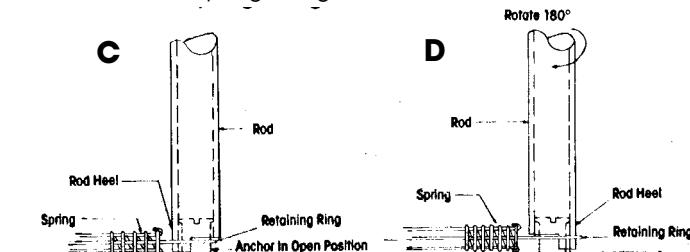

## COVER INSTALLATION

Insert aluminum installation rod through rounded end of spring (Diagram A).

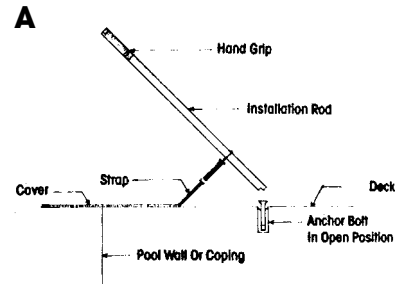

Place heel of rod behind raised anchor. Slip spring over anchor by moving handle away from the pool wall. Remove installation rod by rotating 180° and cover is then installed (Diagram B).

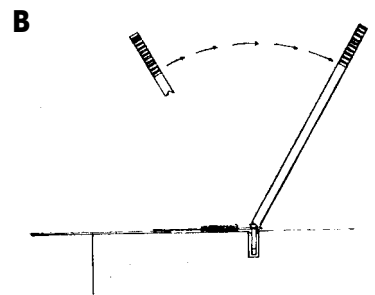

# CUSTOM DECK INSTALLATIONS

(Cover must be installed tautly. Loose-fitting covers can cause excessive abrasion which is not covered by warranty)

## LOOSE BRICK, STONE OR LAWN AND WOOD DECK ONLY IF WOOD DECK IS LESS THAN 1" WIDE.

### METHOD 1

Insert the brass anchor casing into 3/4" ID pipe or conduit which is driven at least 15" into the ground.

#### STEP 1

Locate anchor positions as usual.

#### STEP 2

Drill a hole in the wood deck, loose brick or stone, large enough for a snug fit with the chosen lawn tube.

#### STEP 3

Drive the pipe through the deck surface, with a wood block if possible, until pipe is flush with the surface. If there is a space between a wood deck and the ground, the pipe must be lengthened so that minimum of 15" is driven into the ground.

#### STEP 4

Tap anchor casing with aluminum tamping tool into the pipe until it is flush with the pipe.

### METHOD II

The factory aluminum stake may be used at times in loose brick, stone, lawns and planters. The aluminum stake will not hold adequately in loose soil. **Method 1 is safer and should be used without exception when more than three (3) tent stakes are necessary in succession.**

---

## CARE & MAINTENANCE

- The springs should be very taut upon initial installation. In time, the cover will relax and the tension will ease.
- The cover is designed to screen out leaves and other debris. Clear water can only be maintained if proper levels of chlorine and algaecide are maintained.
- Water levels must be maintained within 18" of the top of the pool during the snow season. Failure to do so will place undue strain on the cover and void the warranty.
- Debris may be easily hosed off of a properly installed cover.
- Removal and subsequent installation is made easier if the cover is fan-folded.
- Store the cover in the mesh storage bag included. Hang the bag off the floor so the cover can drain.
- Flush out anchor casings with a hose several times a year to prevent sticking.
- For Secur&Clean® owners: To clean the debris screen, remove cover, open and fold back the mesh panel on top of the cover. Hose the filter screen off from behind to remove fine debris. Close panel and store.



## WARNING!

**AVOID DROWNING RISK**

- STAY OFF COVER.
- REMOVE COVER COMPLETELY BEFORE USE.
- SUPERVISE CHILDREN.
- IMPROPERLY SECURED COVERS ARE A HAZARD.
- FAILURE TO FOLLOW ALL INSTRUCTIONS MAY RESULT IN INJURY OR DROWNING.
- MEETS OR EXCEEDS STANDARD PERFORMANCE SPECIFICATION SET FORTH IN ASTM DESIGNATION: F 1346-91.